



WT 9200

WATT TRANSDUCER
Instruction Manual

IM-2

September 2003

USA: 6428 Ridglea Drive, Watauga, Texas 76148
Tel/Fax 1-817-427-2060/2067
E-mail: wes@westecinstruments.com

SPECIFICATIONS

Power Supply

Input

Power Range	0 to 1000 Watts Nominal 3 Phase, 3 Wire, 120 V, 5 Amps per element or to customer requirements
Input Voltage	0 to 120 Volts Nominal
Potential Burden	Approximately 0.25 VA @ 120 VAC
Input Current	0 to 5 Amps Nominal – Linear to 7.5 Amps
Current Burden	Approximately 0.02 VA
Power Factor Range	Unity to Zero Lead or Zero Lag
Overloads	Voltage: 200 Volts Maximum Current: 10 Amps Continuous 50 Amps for 10 Seconds 250 Amps for 1 Second
Terminal Blocks	300 Volt Maximum Rating

Output

Current	Standard: 4 – 20 mA into a maximum load of 750 Ω
Voltage	Optional: 0 – 10 VDC into a maximum load of 1000 Ω , with an external 450 Ω , ½ Watt, 1% resistor
Special	Optional – Current or voltage outputs calibrated

Note: Outputs are floating and either or neither side of the circuit may be grounded.

Repeatability $\pm 0.1\%$ of Full Scale

Linearity $\pm 0.25\%$ of Full Scale

Temperature

Recommended	-4°F to +150°F (-20°C to +65°C)
Permissible	-40°F to +150°F (-40°C to +65°C)

Note: The maximum effect on accuracy of the temperature variation limits above is above is $\pm 0.25\%$ of full scale

Dielectric Test 1500 Volts RMS

Adjustments

Zero	Permits elevation or suppression of the Output Zero from 0 to $\pm 40\%$ of full span
Span	Allows output full scale calibration from 0 to 250 through to 0 to 1040 watts total
Damping	Permits selection of the time required for the output to settle to a steady value after a change of input signal. Response Time: 0.25 seconds to 2 minutes.

DESCRIPTION

The Model WT 9200 Watt Transducer is a device that converts AC voltage and current input signals into an analog DC output. The output from the transducer represents a measure of the true power consumed by the load. This is the solid state equivalent of the two wattmeter method of measurement of three-phase power. The output is either a current or voltage signal which is proportional to the true RMS power consumed by the load. True RMS Power is denoted by $VA \cos \phi$.

Due to the solid state design the WT 9200 Watt Transducer has long life, low power burden and high accuracy in the presence of waveform distortion.

Model WT9212 is available with a current output signal of 4 – 20 mADC.

Model WT9216 is available with a voltage output of 0 – 10 VDC.

Model WT9210 units are specially calibrated to customer specifications as required.

The output can be adjusted for full scale with an input of 0 – 250 through 0 – 1040 total watts of 3 phase, 3 wire power. This is equivalent to a maximum of 125 – 520 watts per element. It should be noted that single phase watts per element are used to calibrate the transducer at full scale and calibrated watts should be within the specification limits. The calibration formula is:

$$\text{Calibration Watts per Element} = \frac{\text{Full Scale Watts}}{(\text{CT Ratio}) \times (\text{PT Ratio}) \times 2}$$

INSTALLATION

The Watt Transducer is normally mounted on a vertical surface using the mounting hole dimensions shown in drawing 1-9501112Z-DU-A. This connection should be studied carefully prior to installing, operating or servicing this equipment. Drawing 1-9501112Z-DU-A must be followed exactly when making interconnections with auxiliary equipment.

Normal installation and wiring practices, which are adequate for low level signal cables, should be followed for output wiring from the transducer. It is recommended that output signal wiring be kept separated from the power cables. Wiring connections are required for four input signals. Two signals are from Potential Transformers (PT's) and two are from Current Transformers (CT's).

Note: **Wiring for input signals and the power supply should be in accordance with local requirements and standard practices.**

The two Potential Transformers are required to have a secondary voltage of 120 VAC for rated line to line primary input voltage. The secondary connections are made to terminals 1, 2, 3 & 4 as shown in drawing 1-9501112Z-DU-A. When measuring 3 phase power the maximum burden is approximately 0.25 VA.

The two Current Transformers are required to have a secondary current of 5 Amps for maximum rated primary current. The secondary connections are to be made to terminals 5, 6, 7 & 8 as per drawing 1-9501112Z-DU-A. When measuring 3 phase power, the maximum burden is approximately 0.02 VA.

Caution: **Never energize a current transformer with the secondary circuit open. Input overloads to the transducer may damage unprotected auxiliary equipment.**

CALIBRATION PROCEDURE

The Model WT 9212 Watt Transducer is normally calibrated for 0 – 500 watts per element, which is equivalent to 0 – 1000 watts of three phase power. This calibration produces an output of 4 mA at 0 watts and 20 mA at 500 watts per element.

Specially calibrated units are available to meet customer's specifications as required. These units have the watts per element rating recorded on the calibration plate.

The procedure for checking or changing the calibration on Model WT 9212 is as follows:

- A) Determine the existing calibration from the nameplate or by use of the formula:

$$\text{Calibration Watts per Element} = \frac{\text{Full Scale Watts}}{(\text{CT Ratio}) \times (\text{PT Ratio}) \times 2}$$

- B) Connect a single phase wattmeter and a load to the transducer. See drawing 1-9501111Z-DU-A for method of connections.
- C) Adjust the Damping potentiometer fully counterclockwise to the "Fast Response" setting.
- D) Adjust the load to 0 watts on the wattmeter. Then adjust the Zero potentiometer for 4 – 20 mADC output.
- E) Adjust the load for the calibration watts on the wattmeter. Adjust the Span potentiometer for 4 – 20 mADC output.
- F) Repeat steps D and E to confirm the adjustments. Check for linearity.
- G) When the calibration is satisfactory, adjust the Damping potentiometer clockwise to suit the requirements.

CALIBRATION NOTES

- 1) Model WT 9212 may be calibrated with 4 mA output equal to 40% of the watts at 20 mA output. Modify step D as required.
- 2) For negative watts, all connections to the potential input terminals must be reversed during calibration. This requires interchanging terminal 1 with 2 and terminal 3 with 4. After calibration return connections to the original locations.
- 3) Calibration for Model WT 9210 follows the above procedure except outputs are modified to meet the unit calibration specifications.
- 4) Model WT 9216 calibration is as above with step D adjustment at 0 V and step E adjustment at 10 V.
- 5) Span calibration setting may be at any level from 125 – 600 watts. Settings above 520 watts, however, are in excess of the normal ratings of the potential and current transformers and should only be used to indicate overload conditions.

Should it not be possible to select a calibration within the rating limits, contact Westec for assistance.

A typical wattage calculation is:

Maximum Calibration Watts = 120V x 5A x Square Root of 3 = 1040 watts (3 Phase)

$$\frac{1040 \text{ Watts (3 Phase)}}{2} = 520 \text{ watts per element}$$

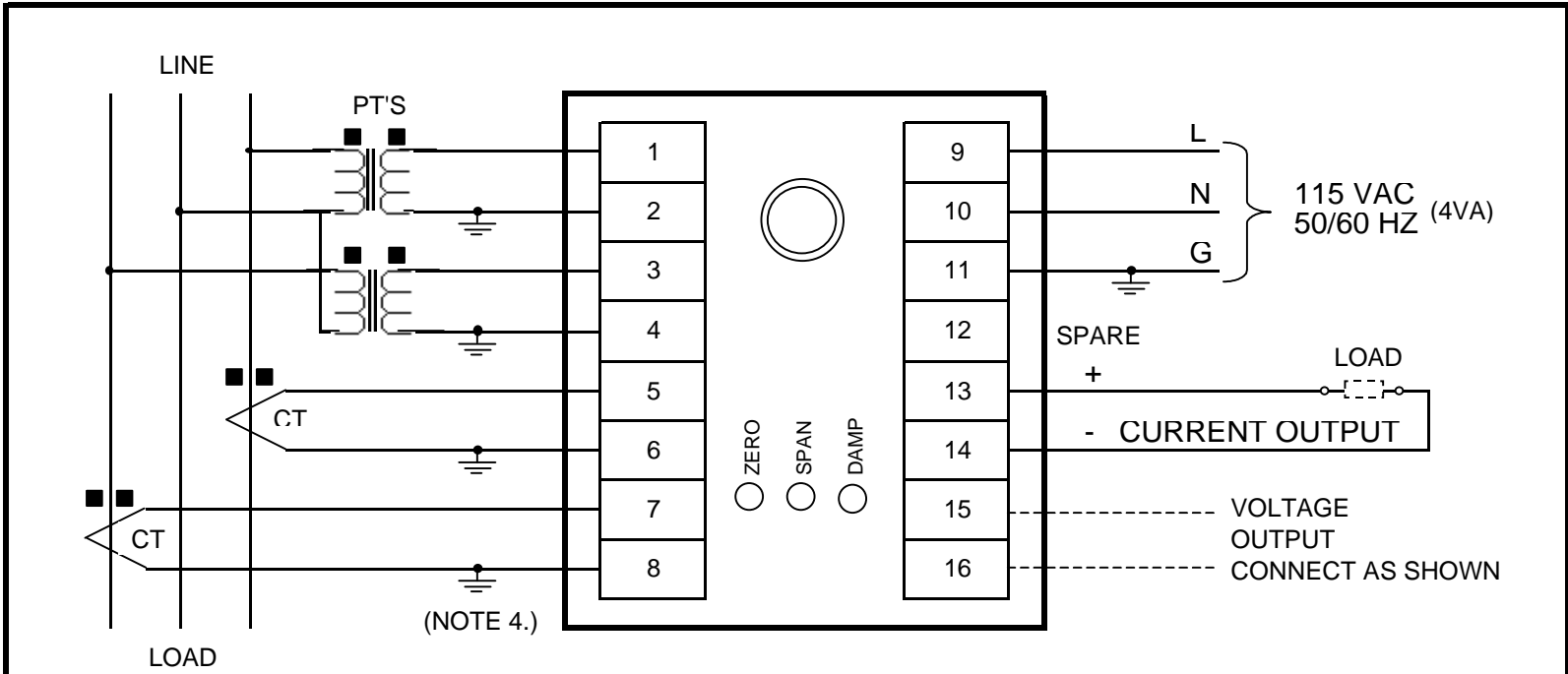

Notes:

1. PT's: 120v. Secondary Burden 0.25va
CT's: 0-5A. Secondary Burden 0.02va
2. All wiring, PT's & CT's by customer.
3. Either current or voltage output is available. The output may be zero based or with an offset zero.
4. CT & PT grounding optional.

CURRENT RANGE	MAX. LOAD	RESISTOR "R" TERM. 13 & 14	CALIBRATION
4 - 20 mA	750 ohm	None	Standard
VOLTAGE RANGE	MIN. LOAD	450 ohm 0.5 watt, 1%	Optional
0 - 10 volts	1000 ohm		

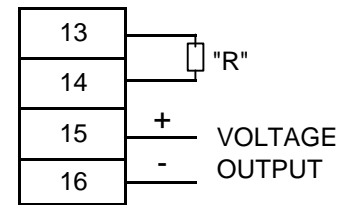

NO.	DESCRIPTION	DATE
REVISIONS		
SCALE	NTS	DATE
DRAWN	WWC	01/01/01
CHECKED	WWC	01/02/01
APPROVED	WWC	01/02/01

TITLE
**WT 9200 WATT TRANSDUCER
 WIRING DIAGRAM**



Westec Instruments

FILE	DRAWING NUMBER	REV
PLOT 1 = 1	1-9501112Z-DU-A	
JOB NO.	SHEET 1 OF 1	0

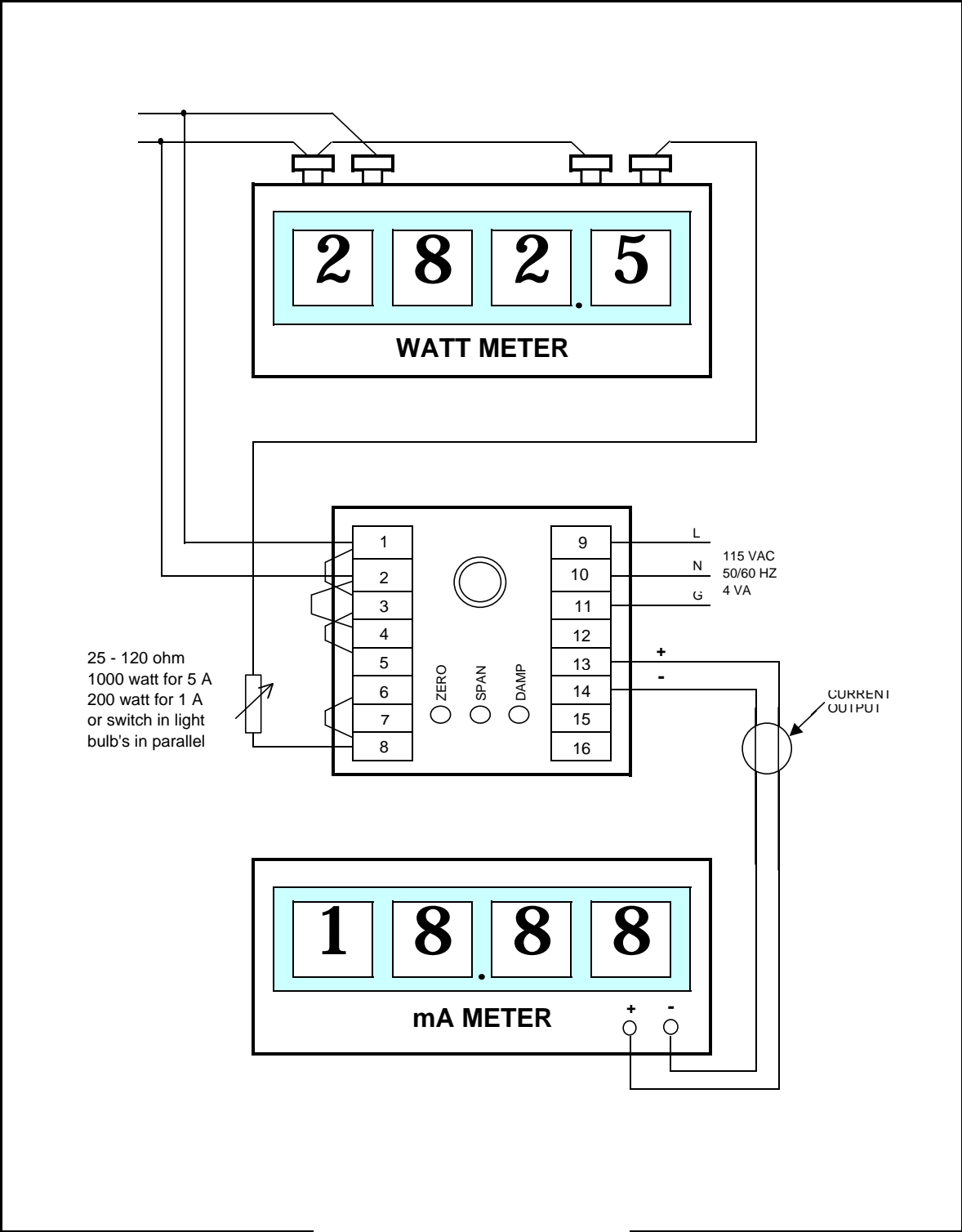

NO.	DESCRIPTION	DATE
REVISIONS		
SCALE	NTS	DATE
DRAWN	WWC	01/01/01
CHECKED	WWC	01/02/01
APPROVED	WWC	01/02/01

TITLE	
WT 9200 WATT TRANSDUCER CALIBRATION CONNECTION DIAGRAM	

		
FILE	DRAWING NUMBER	REV
PLOT 1 = 1	1-9501111Z-DU-A	
JOB NO.	SHEET 1 OF 1	0

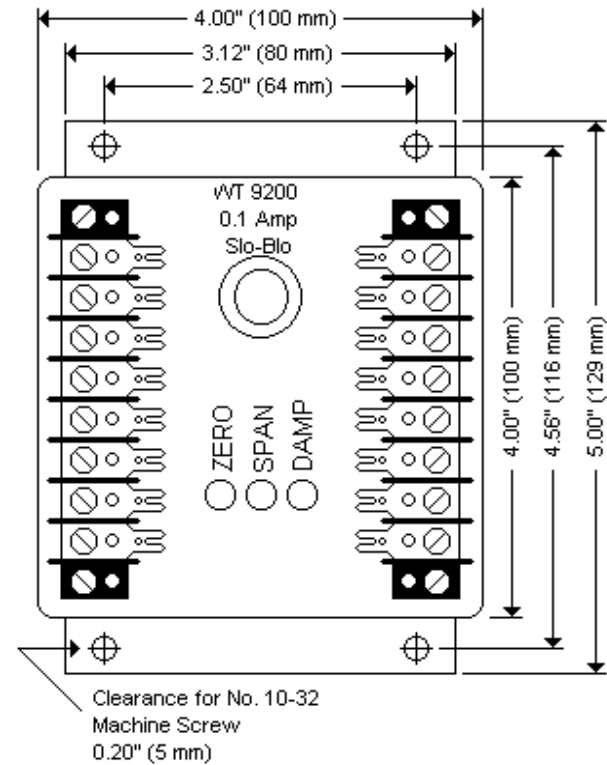
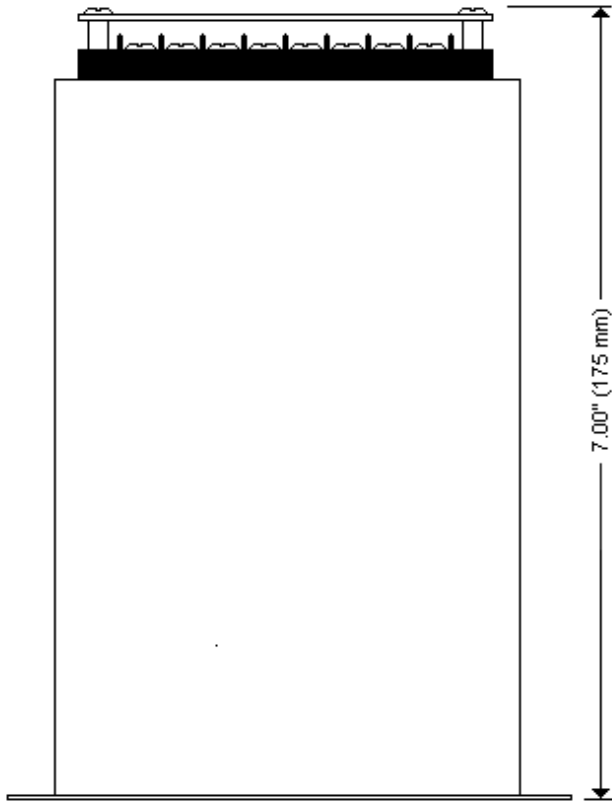

NO.	DESCRIPTION	DATE
REVISIONS		
SCALE	NTS	DATE
DRAWN	WWC	01/01/01
CHECKED	WWC	01/02/01
APPROVED	WWC	01/02/01

TITLE
**WT 9200 WATT TRANSDUCER
DIMENSIONS**



Westec Instruments

FILE	DRAWING NUMBER	REV
PLOT 1 = 1	1-9501113Z-DU-1	
JOB NO.	SHEET 1 OF 1	0